

INLET, PANEL MOUNTING

Part No.	ME 460B9W
Description:	60 Amp 3 250Vac 3 Pole, 4 Wire Inlet
Construction:	Watertight IEC IP 67
Approvals:	UL Listed Standards 1682; 1686 CSA Certification to Spec. C22.2 No. 182.1 IEC 60309-1; IEC 60309-2

IEC COLOR CODE: Blue

GROUND SOCKET: 3 Hour Position Mates with Female in 9 Hour Position.

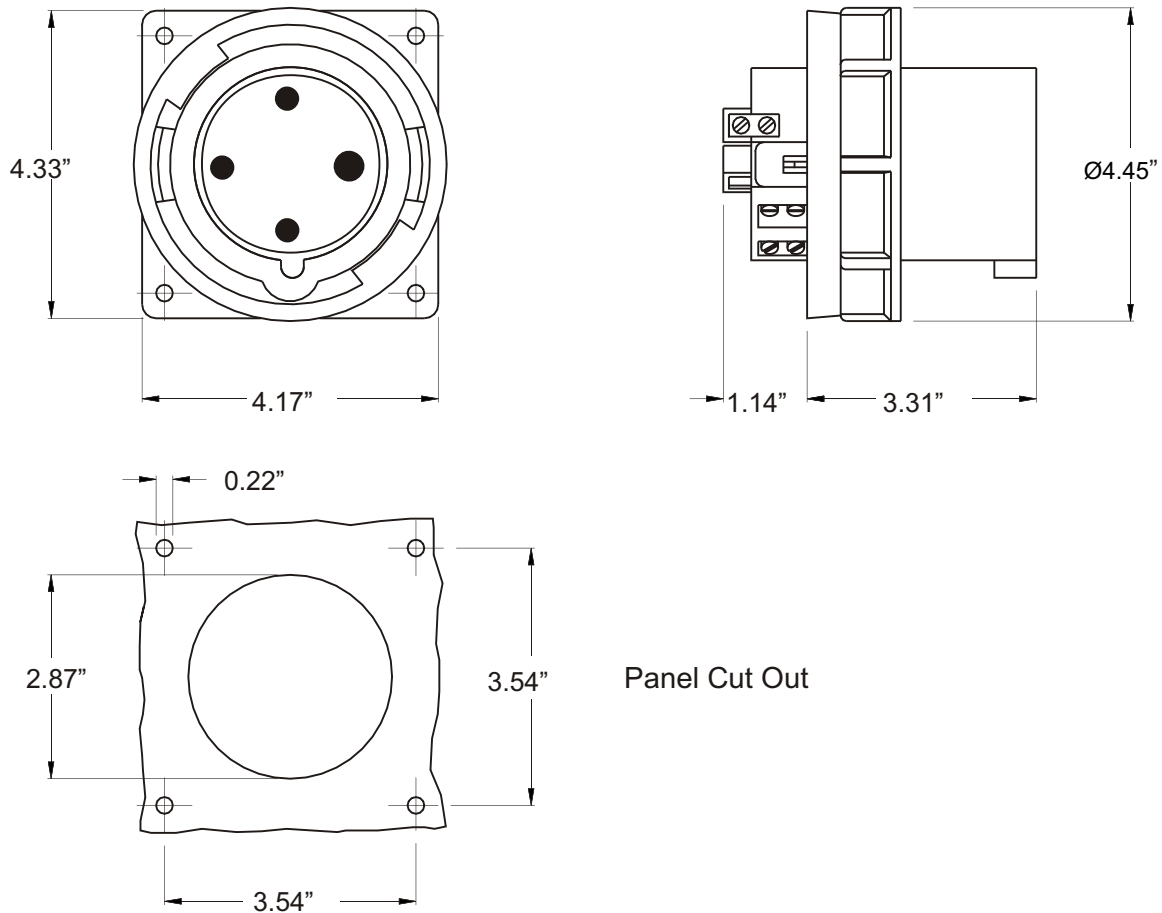

Wire Range: #4 - #8 AWG

Drawing Not to Scale